

POLARITY IN COMMERCIAL TRACK LIGHTS SYSTEM (CTLS)

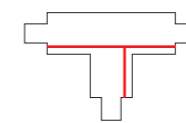

CTLS POWER T CONNECTOR, LEFT 2 (T-L2)

PC, miedź / PC, copper / PC, медь
8236 ○ WH 8237 ● BL

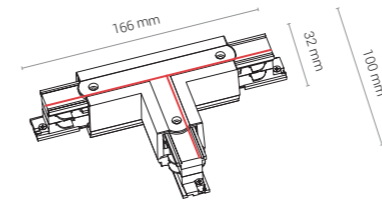
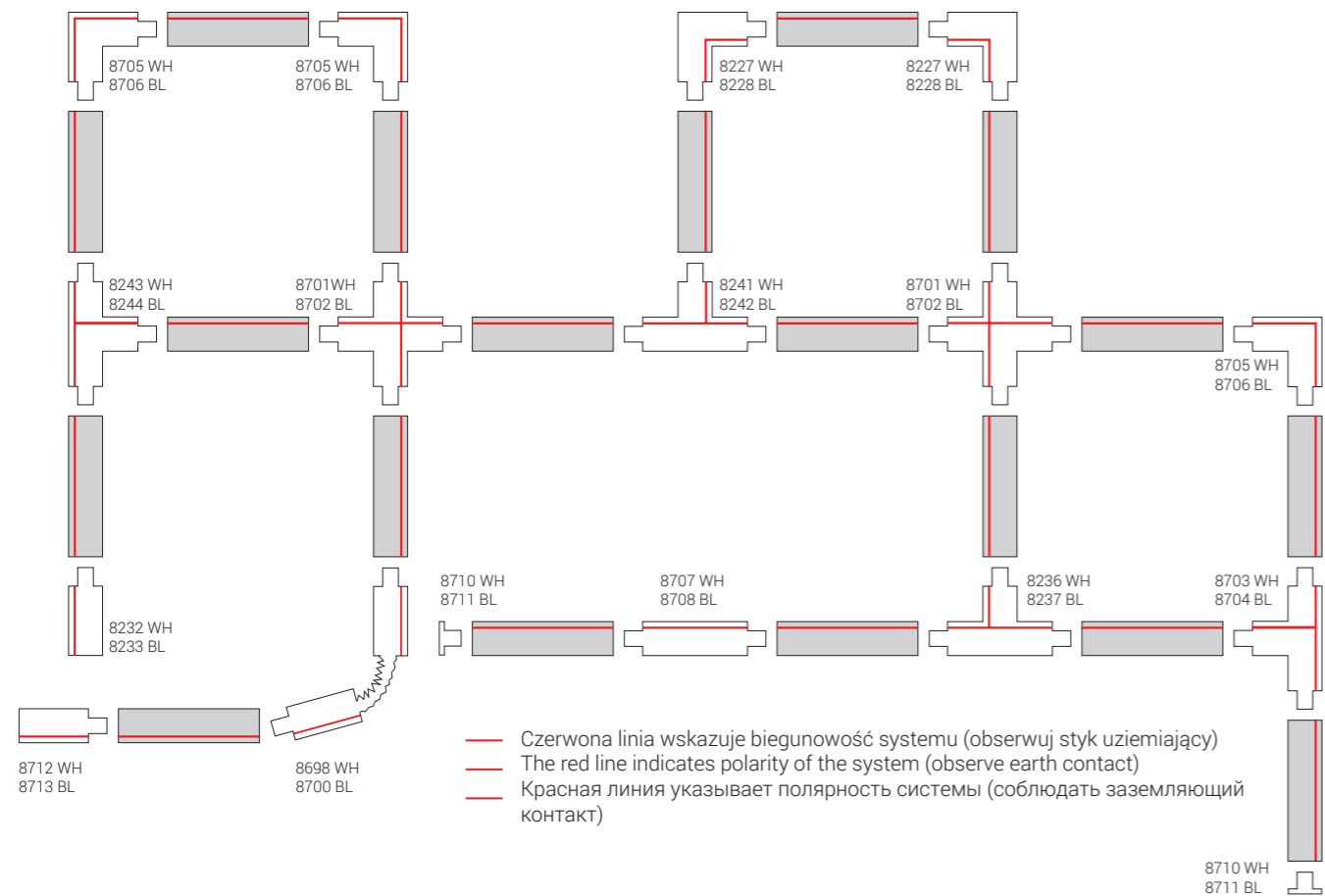
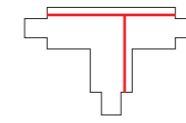
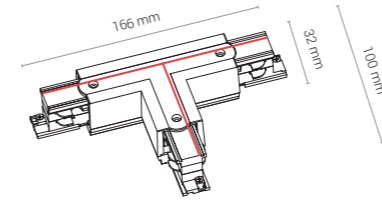

CTLS POWER T CONNECTOR, LEFT 1 (T-L1)

PC, miedź / PC, copper / PC, медь
8243 ○ WH 8244 ● BL

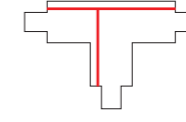
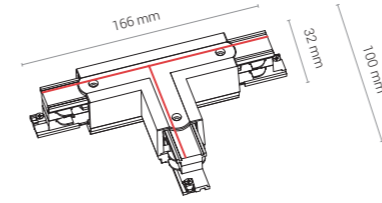

CTLS POWER T CONNECTOR, RIGHT 2 (T-R2)

PC, miedź / PC, copper / PC, медь
8703 ○ WH 8704 ● BL

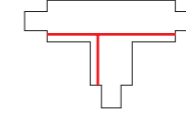
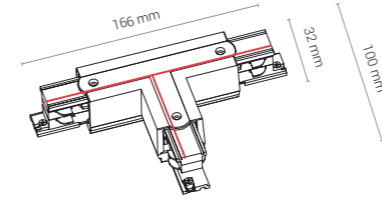

CTLS POWER T CONNECTOR, RIGHT 1 (T-R1)

PC, miedź / PC, copper / PC, медь
8241 ○ WH 8242 ● BL

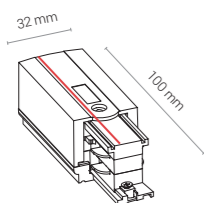

CTLS POWER END CAP, RIGHT (PE-R)

PC, miedź / PC, copper / PC, медь
8712 ○ WH 8713 ● BL

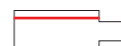
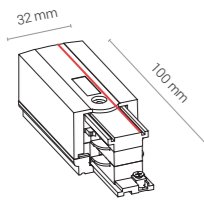

CTLS POWER END CAP, LEFT (PE-L)

PC, miedź / PC, copper / PC, медь
8232 ○ WH 8233 ● BL

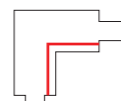
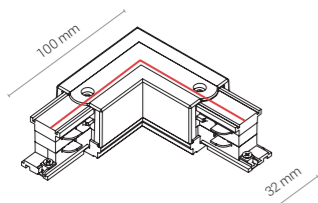

CTLS POWER L CONNECTOR, RIGHT (L-R)

PC, miedź / PC, copper / PC, медь
8227 ○ WH 8228 ● BL

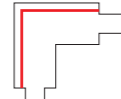
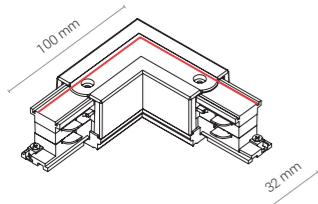

CTLS POWER L CONNECTOR, LEFT (L-L)

PC, miedź / PC, copper / PC, медь
8705 ○ WH 8706 ● BL

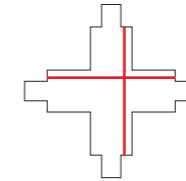
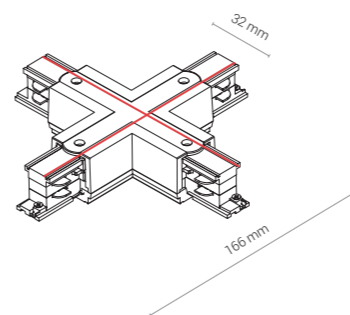

CTLS POWER X CONNECTOR

PC, miedź / PC, copper / PC, медь
8701 ○ WH 8702 ● BL

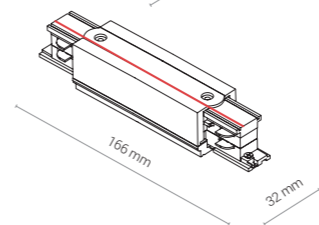

CTLS POWER STRAIGHT CONNECTOR

PC, miedź / PC, copper / PC, медь
8707 ○ WH 8708 ● BL

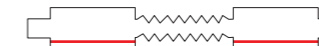
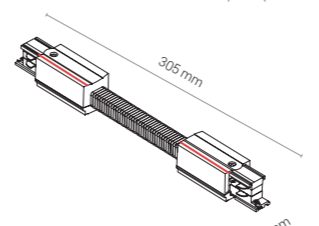

CTLS POWER FLEX CONNECTOR

PC, miedź / PC, copper / PC, медь
8698 ○ WH 8700 ● BL

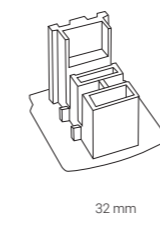

CTLS DEAD END CAP

PC / PC / PC
8710 ○ WH 8711 ● BL